



# 6,2" TFT/LCD 2 DIN NAVIGATION

ITALIANO

ENGLISH

FRANÇAIS

DEUTSCH

ESPAÑOL

**MANUALE ISTRUZIONI • INSTRUCTIONS MANUAL**  
**NOTICE DE MONTAGE ET D'EMPLOI • GEBRAUCHSANWEISUNGEN**  
**MANUAL DE INSTRUCCIONES**

# **VM 067**

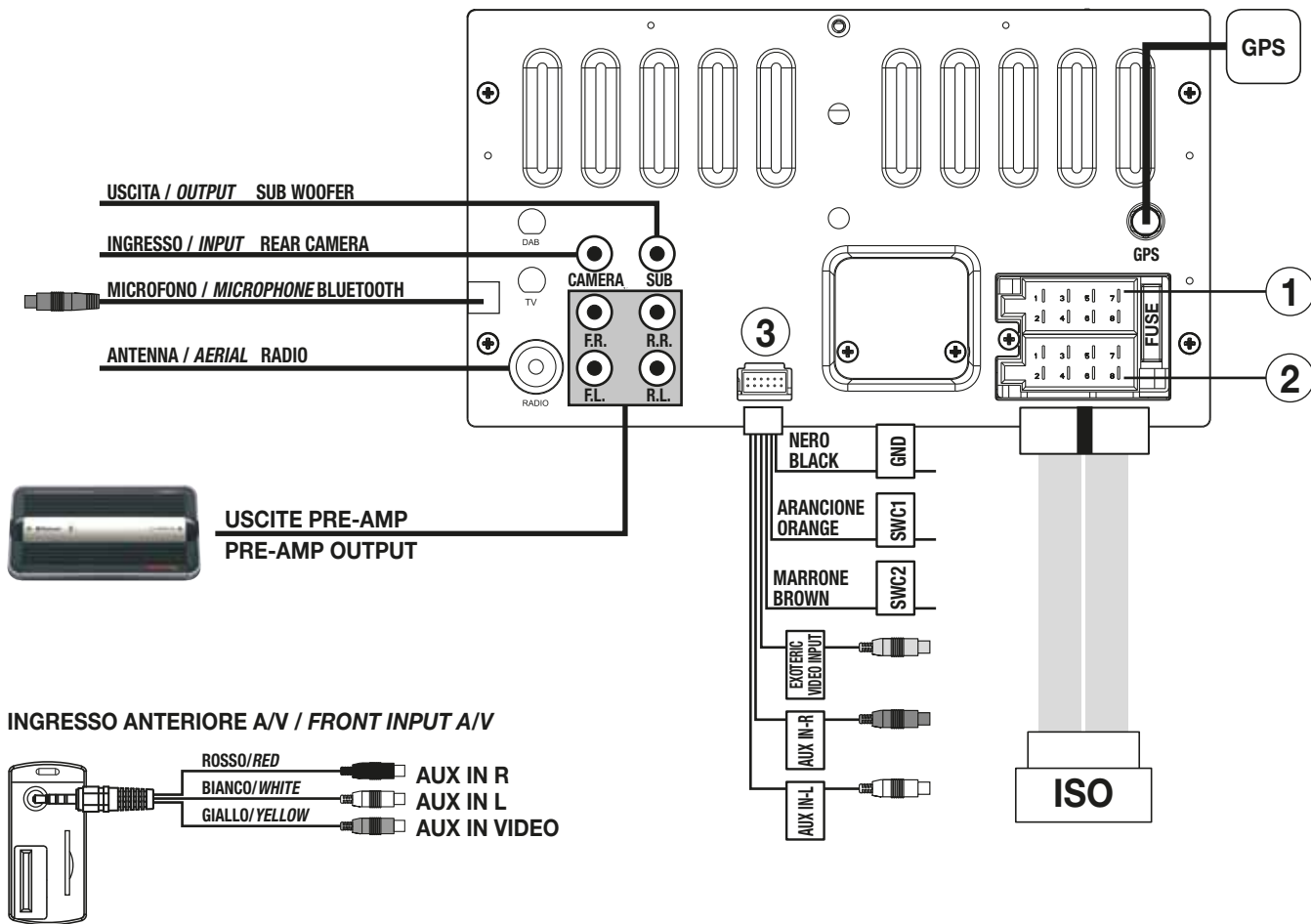

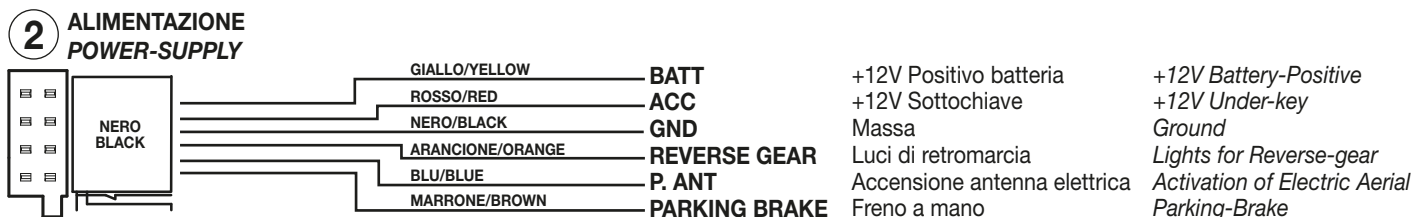
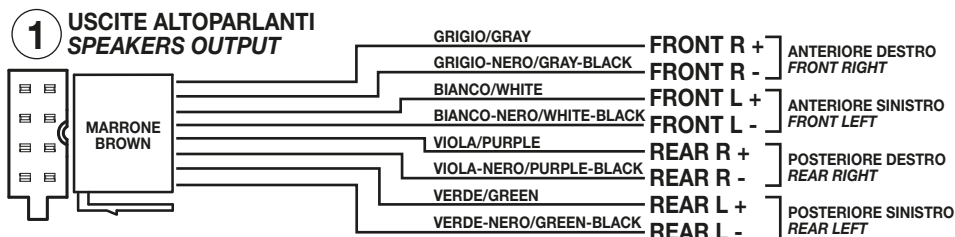

Su alcuni veicoli durante l'avviamento il VM067 potrebbe spegnersi per poi riaccendersi. Per evitare questo inconveniente collegare il temporizzatore di accensione **5/146** (optional) al connettore di alimentazione.

*On some car-models, the VM067 could turn-out and turn-on again, when the ignition-key gets activated. You can avoid such inconvenience, by connecting the ignition-Timer **5/146** (optional) to the power connector.*

**COMANDI AL VOLANTE-INGRESSO A/V / STEERING WHEEL COMMANDS-A/V INPUT**

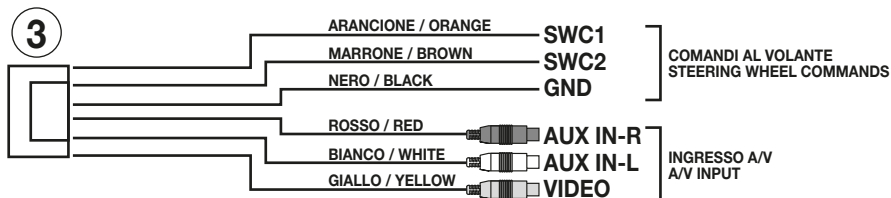

## COMANDI AL VOLANTE CON PROTOCOLLO RESISTIVO / RESISTIVE PROTOCOL STEERING-WHEEL COMMANDS

Per i collegamenti al connettore auto originale utilizzare gli schemi presenti sul manuale connessioni dell'interfaccia 4/083 o 4/085.  
 When connecting to the original car-connector, please refer to the connection-schemes shown in the Manual of Interface 4/083 or 4/085.

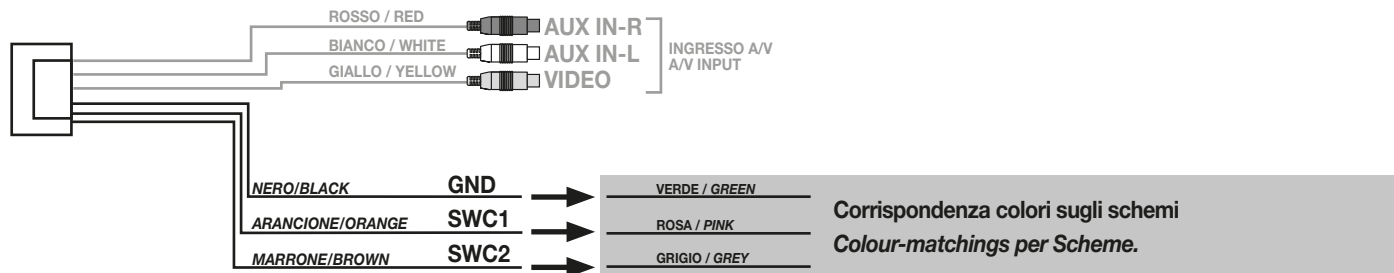

## COMANDI AL VOLANTE CAN-BUS / CAN-BUS STEERING-WHEEL COMMANDS

Utilizzare l'interfaccia CAN BUS 4/070 o 4/073 memorizzando il profilo autoradio su VM041. Assegnare i comandi al volante secondo le istruzioni a pag. 15.  
 Use Interfaces CAN BUS 4/070 or 4/073 by memorizing the radio-profile VM041. Fix the various steering-wheel commands, by following the instructions at page 15.

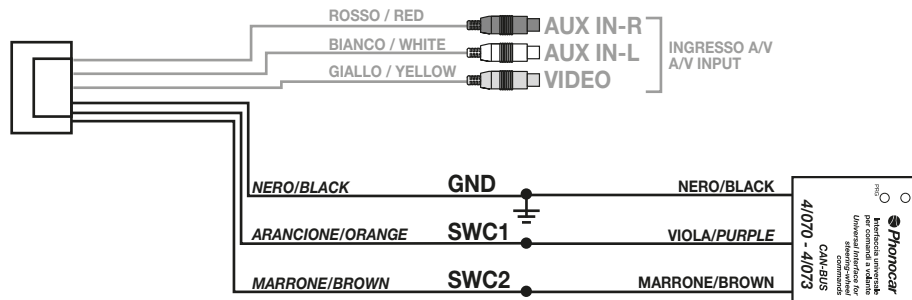

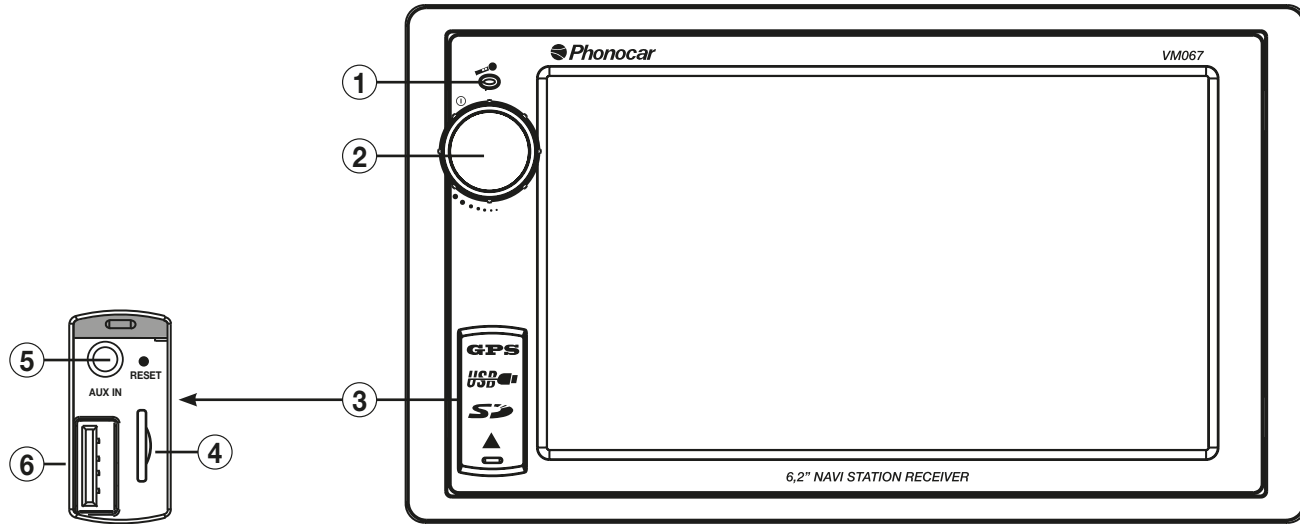

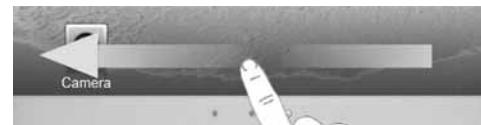
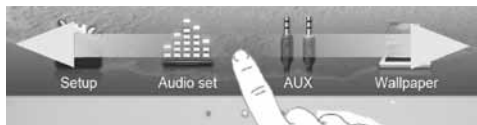

1. Microfono.
2. Accensione-Spegnimento / Volume / Funzione GPS
3. Protezione scorrevole per ingressi AUX IN - SD CARD - USB
4. SLOT per SD CARD GPS
5. AUX IN
6. Porta USB

1. Microphone.
2. Power on-off / Volume / GPS Function
3. Cover for the AUX IN - SD CARD - USB slots
4. Slot SD CARD GPS
5. AUX IN
6. USB port



Premere il tasto Accensione/Spegnimento sul pannello frontale dell'autoradio, comparirà la funzione RADIO, con l'icona  si passa il menù principale. Il menù è formato da tre diverse schermate che si visualizzeranno facendo scorrere il dito sullo schermo. Toccando le icone si seleziona la sorgente o la funzione desiderata.

*Press the Power knob on the front panel, it show the RADIO function, press  to show the main menu. The menu is composed by 3 different pages that can be scrolled by slide the finger on the touch screen. Press on the icons to enter in the different sections.*



Premere l'icona Setup sul pannello del menù principale per modificare i seguenti settaggi: video, audio, orario, sistema, touchscreen.  
 Press Setup icon on the screen to regulate the following settings: video, audio, clock, system, touchscreen.



## VIDEO

Per impostare CONTRASTO-LUMINOSITÀ-COLORE  
 Con le icone Luminoso, Normale e Soft si può regolare anche l'effetto luce su schermo.

## VIDEO

To adjust CONTRAST-BRIGHTNESS-COLOR  
 The screen can be adjust by choosing between Bright, Soft and Normal.



## AUDIO

<> Regola bilanciamento.  
 ▲ Regola Fader.  
 ▼ Regola Bassi.  
 -/+ Regola Alti.  
 -/+ Regola EQ.  
 ■ ■ Attiva/Disattiva SUBWOOFER e LOUDNESS.  
 <> EQ Seleziona 8 diverse modalità di equalizzazione preimpostate.

## AUDIO

<> Balance adjustment  
 ▲ Fader adjustment  
 -/+ Adjusts Bass frequency.  
 -/+ Adjusts Treble frequency.  
 ■ ■ Activate/Deactivate SUBWOOFER and LOUDNESS.  
 <> EQ elect 8 different equalization mode.



## DATA E ORA

⌚ Entra nella schermata d'impostazione.  
 ON/OFF Time Display per visualizzare l'orario.  
 12/24 Time Mode per selezionare il modo di visualizzazione.  
 Time/Date Option per posizionarsi sulla voce da modificare (orario o data). Effettuare le modifiche tramite le icone ▲▼.

## DATE and TIME

⌚ Enter in the Time settings.  
 ON/OFF Time Display to show the clock.  
 12/24 Time Mode to select the time format.  
 Time/Date Option to change the time or date Adjust them with the arrows ▲▼.



## SISTEMA

Etra nella schermata d'impostazione.

- Beep **ON/OFF** attiva/disattiva suono tasti.
- GPS mix **ON/OFF** attiva/disattiva la voce del navigatore.
- LANGUAGE imposta la lingua.
- Radio Region tramite le icone < > selezionare la regione in cui ci si trova.
- Dual color per cambiare la retro illuminazione dei tasti (Rossa-Blu).
- RDS CT Attiva/Disattiva sincronizzazione orologio con RDS.

## SYSTEM

Press icon to enter in the System settings.

- Beep **ON/OFF** activate/deactivate beep on the buttons.
- GPS mix **ON/OFF** activate/deactivate navigator voice.
- LANGUAGE change language.
- Radio Region select < > the region.
- Dual color to change the backlights from red to blue.
- RDS CT Sincronization RDS clock.



## TOUCHSCREEN

Tramite l'icona entrare nella schermata d'impostazione.

Se le immagini sullo schermo e il touch non coincidono, è necessario effettuare la calibrazione. Premere il simbolo **X** presente sullo schermo per più di 2 secondi fino a che non compare la scritta "calibrazione effettuata".

## TOUCHSCREEN

Press icon to enter in the touch screen calibration. When the touch selection is misplaced, you need to make the calibration. Press the X on the screen for 2 seconds until it show "calibration done".



## PERSONALIZZAZIONE SFONDO

Nel menù principale, tramite l'icona (WALLPAPER) si può selezionare una serie di sfondi da applicare allo schermo.

## CUSTOMIZE WALLPAPER

On the main menu, by pressing the icon the background can be changed in different wallpapers.



**RADIO**

Tramite l'icona  si entra nella funzione RADIO.

**RADIO**

Press icon  to enter in RADIO function.

**RICERCA STAZIONI**

**Automatica.** Per sintonizzarsi in automatico su una stazione toccare le icone <> sul touchscreen.

**Manuale.** Per sintonizzarsi in manuale su una stazione tenere premuto le icone <> sul touchscreen. Possono essere salvate fino a 30 stazioni (18 FM e 12 MW).

**RESEARCH STATION**

**Automatic.** For tuning automatically, press the buttons <> on the touchscreen.

**Manual.** For tuning manually keep pressing the buttons <> on the touchscreen. It can save up to 30 stations (18 FM and 12 MW).

**SALVATAGGIO STAZIONI**

**Automatico.** E possibile salvare fino a 6 stazioni per ogni banda. Selezionare la banda desiderata e tener premuto il tasto AMS, in automatico verranno salvate stazioni con buona ricezione.

**Manuale.** Per salvare una specifica stazione radio, sintonizzarsi e tener premuto uno dei tasti (1-6). Ogni stazione precedentemente salvata sullo stesso numero verrà cancellata.

**MEMORIZING STATIONS**

**Automatic.** It can save up to 6 stations for each band. Select the band and keep pressing the AMS button, station with good reception will be saved automatically.

**Manual.** To save a specific radio station, tune on it and keep pressing in one of the 6 buttons below (1-6). Every station previously saved on the same number will be cancelled and overwritten.



**FUNZIONI RADIO**

- **BAND** Seleziona Bande Radio 3 FM - 2 AM.
- **AMS** Scansiona le frequenze radio automaticamente e memorizza le prime 6 più forti.
- **INTRO** per ascoltare i primi secondi di ogni stazione radio memorizzata.

**RADIO FUNCTION**

- **BAND** Select Band Radio 3 FM - 2 AM.
- **AMS** Scan the radio frequencies and saved the 6 radio stations with best reception.
- **INTRO** to listen to the first seconds of every saved station.



**FUNZIONI RADIO**

- **RDS** visualizza informazioni  
 PI Programma di identificazione  
 PS Programma nome  
 AF Lista frequenze alternative  
 TP Programma traffico  
 TA Informazione sul traffico  
 PTY Seleziona tipo programma musicale.
- ⚙ Per entrare nel menù di impostazione.

**RADIO FUNCTION**

- **RDS** Info  
 PI Programma di identificazione  
 PS Name program  
 AF Alternative frequencies list  
 TP Traffic Program  
 TA Traffic info  
 PTY Select program type.
- ⚙ To enter on the settings Menu.



**IMPOSTAZIONI RADIO**

- ⚙ Per entrare nel menù di impostazione.
- ON/OFF** attiva o disattiva servizio.
- LOC • ST • EON • PTY • TA • AF • REG

**RADIO SETTINGS**

- ⚙ To enter on the Radio settings Menu.
- ON/OFF** Activate and deactivate the following functions:  
 LOC • ST • EON • PTY • TA • AF • REG



## FUNZIONI USB/SD

All'inserimento di USB/SD il contenuto verrà visualizzato automaticamente. Selezionare il tipo di file tramite l'icona relativa. **MUSICA - VIDEO - IMMAGINI.**

**PLAYING** per avviare la riproduzione.

## USB/SD FUNCTIONS

*When a USB/SD device is connected, the files will be displayed automatically.*

*Select the type of file you want to play by pressing the buttons. **MUSIC - VIDEO - IMAGES.***

***PLAYING** to start to play.*



## RIPRODUZIONE MUSICA

Selezionare la traccia desiderata per avviare la riproduzione.

- ▶|| Per avviare o interrompere la riproduzione.
- Stop alla riproduzione.
- ⏮⏭ Per cambiare la traccia.
- 🔄 Ripetizione traccia/cartella/disco.
- 📱 Per selezionare una traccia specifica usando i numeri da 0-9.

## MUSIC PLAYBACK

Select the music file to play.

- ▶|| To Start/interrupt reproduction.
- Stop reproduction.
- ⏮⏭ Skip track.
- 🔄 repeat track/folder/disc.
- 📱 To select a specific track by digit numbers form 0 to 9.

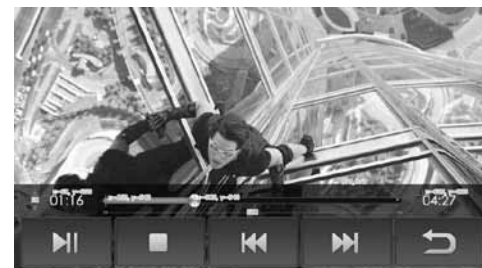

## RIPRODUZIONE VIDEO

- ▶|| Per avviare o interrompere la riproduzione.
- Stop alla riproduzione.
- ⏮⏭ Per avanti/indietro veloce e capitoli.
- 🔄 Per tornare al menù.

Toccare lo schermo per fare apparire il menù quando il filmato è in riproduzione.

## VIDEO PLAYBACK

- ▶|| To Start/interrupt reproduction.
  - Stop reproduction..
  - ⏮⏭ To go fast forward or backward and skip chapter.
  - 🔄 To go back to menù.
- Touch th screen to show the buttons while is playing.

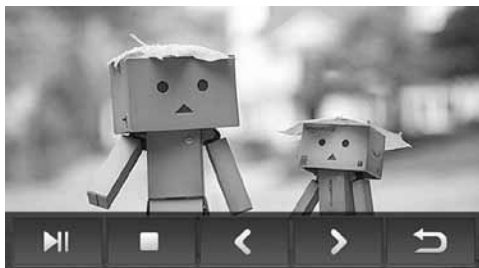

### RIPRODUZIONE FOTO

- ▶❏ Per avviare o interrompere la riproduzione.
- Stop alla riproduzione.
- <> Per avanti/indietro veloce e capitoli.
- ↶ Per tornare al menu.

Toccare lo schermo per fare apparire il menù quando le immagini sono in riproduzione.

### PICTURE PLAYBACK

- ▶❏ *To Start/interrupt reproduction.*
- *Stop reproduction.*
- <> *To go fast forward or backward and skip chapter.*
- ↶ *To go back to menù.*

*Touch th screen to show the buttons while the pictures are playing.*



## ACCOPIAMENTO TELEFONO

Selezionare modalità BT sul menù principale.

- Attivare la funzione bluetooth sul telefono e ricercare nuovi dispositivi.
- Selezionare VM067 nella lista dispositivi, inserire la password 1234 quando richiesta.

Ad accoppiamento avvenuto comparirà il nome del telefono.

## PHONE PAIRING



*Press on the BT icon on the menù to enter in the BT function.*

- *Activate the bluetooth connection on the phone and search the new devices.*
- *Select VM067 on the devices list, insert the password 1234 on request.*



*As soon as the connection has been accomplished the phone name will be shown.*



## SINCRONIZZAZIONE RUBRICA

-  **Contacts** Premere per entrare in Rubrica e Registro chiamate.
-  Premere per scaricare la rubrica del telefono nella memoria dell'autoradio. Il tempo per l'operazione varia in base al numero dei contatti.

## PHONE-BOOK SYNCHRONIZATION

-  **Contacts** *Press to enter the Phone-Book and Conversations-List.*
-  *Press to download the Phone-Book into the radio-memory. This operation varies in due relation with the number of phone-contacts involved.*

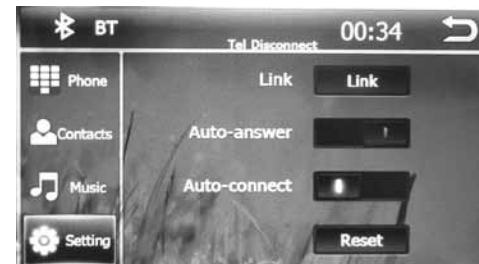

## OPZIONI BLUETOOTH

- **LINK** Premere su questo tasto per accoppiare unità e cellulare manualmente.
- **AUTO-ANSWER** Imposta la risposta automatica.
- **CONNECT** Imposta la riconnessione automatica.
- **RESET** Per cancellare le impostazioni Bluetooth.

## BLUETOOTH OPTIONS

- **LINK** *Press this button to connect manually the device to the cellphone.*
- **AUTO-ANSWER** *answer automatically all incoming calls.*
- **CONNECT** *provides for the automatic phone-connection.*
- **RESET** *Reset all the Bluetooth settings.*



## CHIAMARE DALLO SCHERMO

- Chiamata dal tastierino numerico.
- Chiamata da rubrica telefonica.
- Entra nella funzione audio streaming.
- Opzioni Bluetooth
- Invia una chiamata.
- Termina la conversazione o rifiuta la chiamata in arrivo.

Note: La chiamata in arrivo interromperà altre funzioni che verranno ripristinate al termine.

## CALLING FROM THE SCREEN

- Calls effected through number-keys.
- Calls through the phonebook.
- Emter in audio streaming function.
- Bluetooth Options
- Make a call.
- End the conversaton or refuse the in-coming call.

Note: incoming call will stop other functions that will be restored after the call.



## RICEVERE UNA CHIAMATA

Quando è in arrivo una chiamata, su metà di-screen verrà visualizzato il numero chiamante.

- Risponde a una chiamata.
- Termina la conversazione o rifiuta la chiamata in arrivo.

## RECEIVING A CALL

*When a phone call arrives, on half-screen will be displayed the number that is calling.*

- Answer the call.
- End the conversaton or refuse the in-coming call.



## RIPRODUZIONE MUSICA BLUETOOTH

Se il telefono connesso supporta il profilo A2DP è possibile ascoltare i brani musicali.

Se il dispositivo supporta AVRCP sarà possibile controllare i brani musicali direttamente dal touch screen.

- Per avviare o interrompere la riproduzione.
- Stop alla riproduzione.
- Seleziona brano precedente/successivo.

## BLUETOOTH MUSIC PLAY

*If the connected phone supports the A2DP profile, you can listen to music.*

*If the device supports AVRCP the musical tracks can be handled on the touch screen directly.*





- To start or end reproduction.
- Stop reproduction.
- Select next/previous tracks.



## IMPOSTAZIONE COMANDI VOLANTE

 Premere l'icona per entrare nella programmazione dei comandi al volante.





Seguire la seguente procedura:

- 1 Premere uno dei riquadri sulla sinistra dello schermo (es. casella 1).
- 2 Premere sul volante della vettura il comando da assegnare (es. ).
- 3 Trascinare l'icona della funzione desiderata (es. ) nel riquadro selezionato.
- 4 Ripetere la sequenza da 1 a 3 per tutti i comandi presenti sul volante.
- 5 Terminata l'assegnazione premere  e uscire dalla programmazione premendo .

Per cancellare un comando assegnato trascinarlo dal riquadro a sinistra al riquadro delle funzioni a destra.

## FIXING THE STEERING-WHEEL COMMANDS

 Press icon to enter the steering-wheel programming-function, and effect following procedure:

- 1 Press one of the given Cells you find on the left of the screen (example: cell 1)
- 2 On the steering-wheel, press the command you have to fix (example )
- 3 Drag the icon of the requested command (example ) into the selected Cell.
- 4 Repeat operations 1-2-3 for every single steering-wheel command.
- 5 When all commands have been fixed, press  and quit programming-function, by pressing .

*If you need to cancel a fixed command, drag the related command from the Cell on the left, to the Cell on the right of the screen.*



## NAVIGAZIONE

Alla prima attivazione della mappa iGO (optional) accedere al menu impostazioni del software.

## NAVIGATION

Enter the Software-Setup-Menu on the iGO maps optional.



## IMPOSTAZIONE MODULO GPS

▶ • Passa alla seconda schermata

## SETTING THE GPS-MODULE

▶ • Go to the second panel.



▶ GPS • Premere GPS.

▶ GPS • Press GPS.



• Premere sulla spunta di GPS ATTIVO poi su RILEVAMENTO AUTOMATICO.

• Press to tick GPS-ACTIVE then press AUTOMATIC REVEALING.



• Attendere l'acquisizione dei dati e premere ok.  
• Riferirsi al manuale iGO per le istruzioni sul software di navigazione.

• Wait for Data-collection and press ok.  
• Check iGO-Manual and follow the related navigation-software instructions.



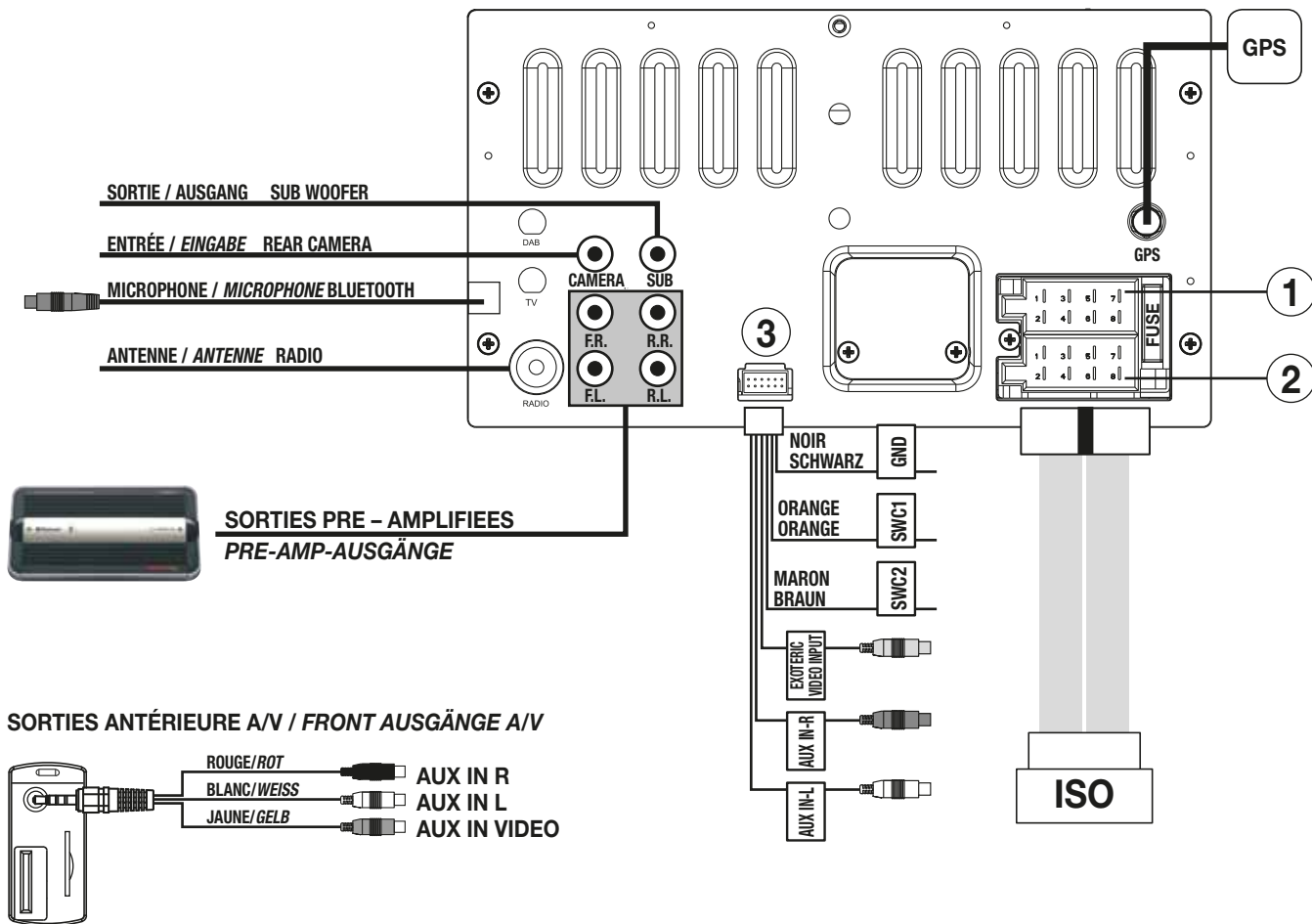

## 1 SORTIES HAUTS-PARLEURS LAUTSPRECHER-AUSGÄNGE

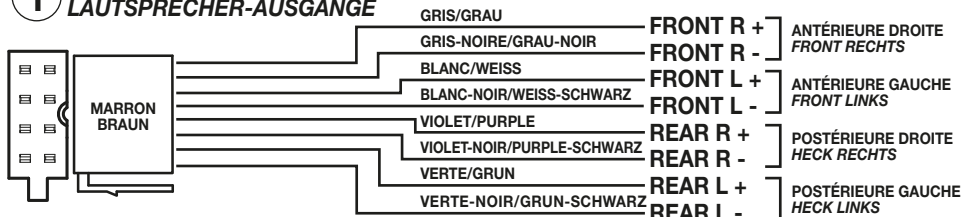

## 2 ALIMENTATION STROM-ZUFUHR

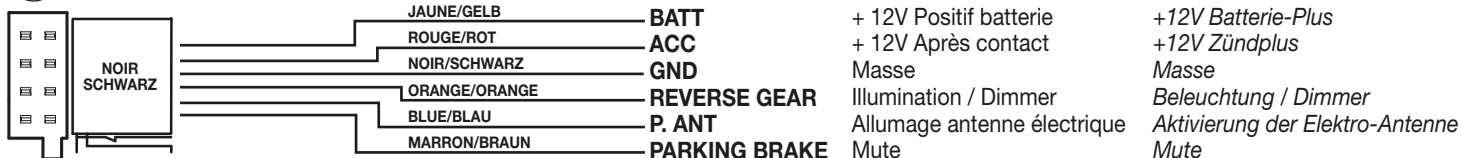

Sur certaines voitures, pendant l'allumage, le VM067 peut s'éteindre avant de se rallumer. Pour éviter cet inconvénient, brancher le temporisateur d'allumage 5/146 au connecteur d'alimentation.

Auf einigen Wagen-Modellen kann es vorkommen, dass beim Anlassen des Motors, der VM067 sich von selbst ausschaltet und dann wieder einschaltet. Diesen Umstand kann man verhindern, indem man den Zeitgeber 5/146 am mit dem Netzanschluss.

## COMMANDES AU VOLANT-ENTREE A/V / LENKRAD-STEUERUNGEN-A/V EINGABE

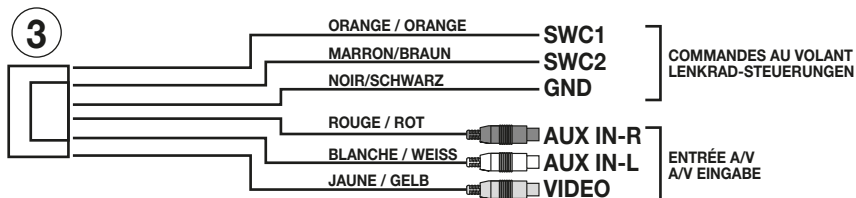

## COMMANDES AU VOLANT RÉSISTIVES / RESISTIV-LENKRAD-STEUERUNGEN

Pour les branchements au connecteur original de la voiture, se servir des schémas présents sur la notice de l'interface 4/083 o 4/085.

Beim Anschließen an den Original-Stecker des Wagens, bitte den Anschluss-Plan in der Gebrauchsanweisung der Interface 4/083 o 4/085, befolgen.

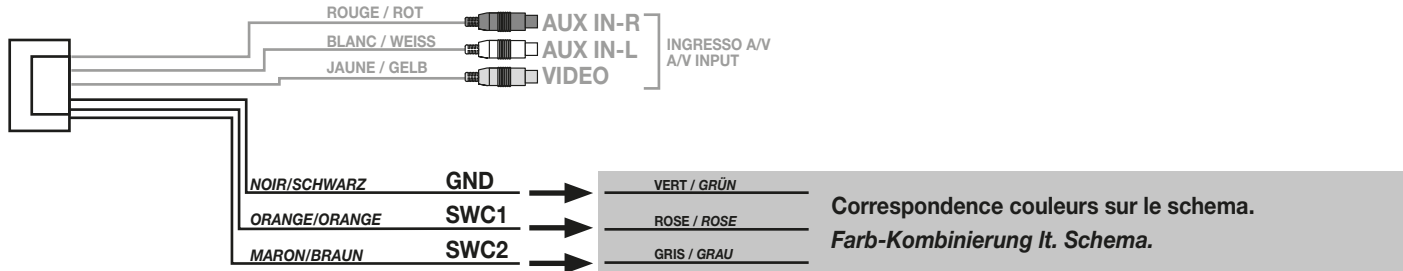

## COMANDI AL VOLANTE CAN-BUS / CAN-BUS STEERING-WHEEL COMMANDS

Utiliser l'interface CAN BUS 4/070 ou 4/073 en mémorisant le profil autoradio sur VM041. Assigner les commandes au volant selon les instructions à la page 15.

Die CAN-BUS-Interface 4/070 oder 4/073 unter dem Autoradio-Profil VM041 verwenden. Die verschiedenen Lenkrad-Steuerungen lt. Anweisungen auf Seite 15 festlegen.

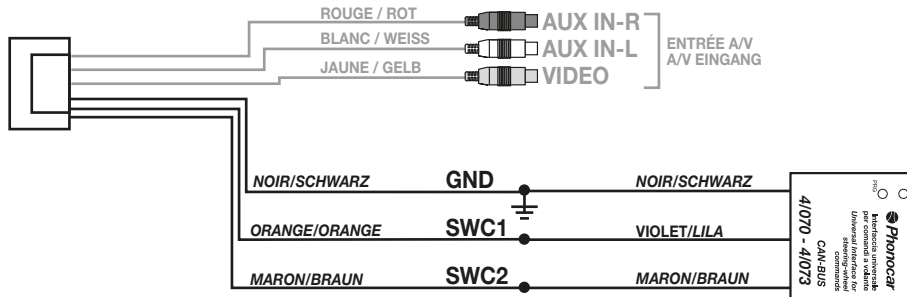

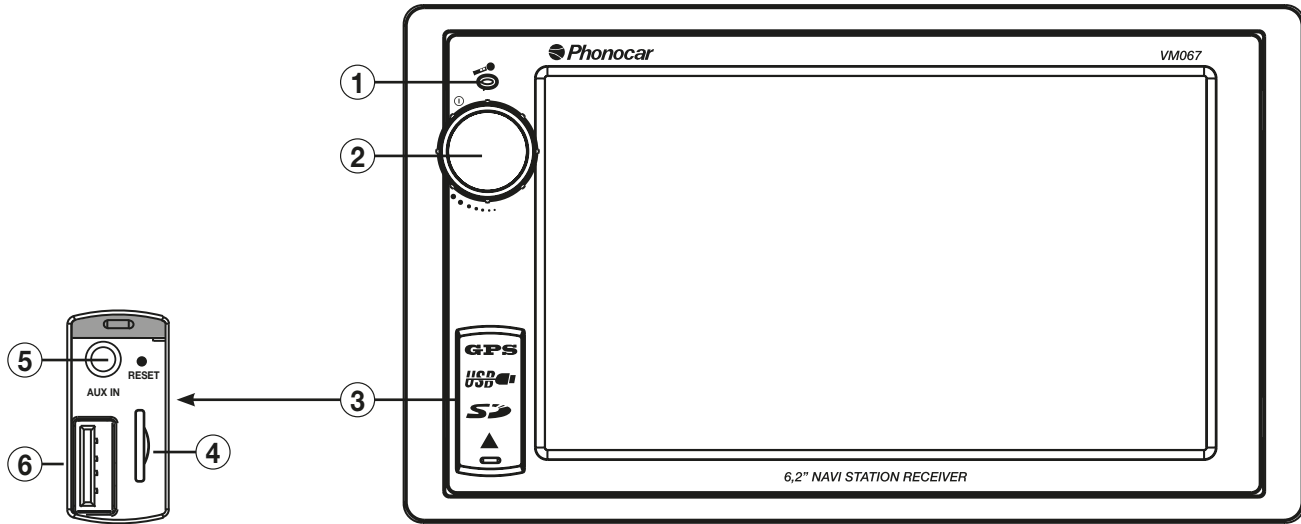

1. Microphone.
2. Allumage - Extinction / Volume / Fonction GPS
3. Protection coulante pour entrées AUX IN - SD CARD - USB
4. SLOT pour SD CARD GPS
5. AUX IN
6. Porte USB

1. Mikrofon
2. Einschalten-Ausschalten / Lautstärke / GPS-Funktion
3. Schiebe-Abdeckung für AUX-IN – SD – USB
4. Öffnung für GPS-SD-Karte
5. AUX-IN
6. USB-Öffnung

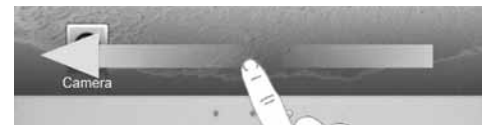
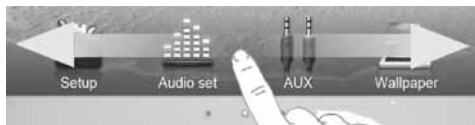

Einschalt-Knopf auf der Radio-Front drücken ↩, so dass das Hauptmenü erscheint. Das Hauptmenü besteht aus 3 verschiedenen Kästen, die durch Abgleiten des Fingers auf dem Bildschirm erscheinen. Gewünschte Quelle und Funktionen, erhält man durch Antasten der betreffenden Ikonen.  
 Im Hauptmenü, die Setup-Ikone drücken, um folgende Einstellungen zu ändern: Video, Audio, Uhrzeit, System, Touch-screen.

Appuyer le touche Allumage/Extinction sur le panneau frontale de l'autoradio, on se visualisera la fonction RADIO, appuyer l'icône ↩ on se visualisera le menu principal. Le menu est constitué par trois différents écrans qui se visualiseront en faisant couler le doigt sur l'écran. En touchant les icônes on sélectionne la source ou la fonction désirée.



Appuyer l'icône Setup sur le panneau du menu principal pour modifier les suivants réglages: vidéo, audio, horaire, système, touchscreen.  
 Im Hauptmenü, die Setup-Ikone drücken, um folgende Einstellungen zu ändern: Video, Audio, Uhrzeit, System, Touch-screen.



## VIDEO



Pour établir

CONTRASTE-LUMINOSITÉ-COULEUR

Avec les icônes **Bright**, **Soft** et **Normale** on peut réguler aussi l'effet lumière sur l'écran.

## VIDEO



Um KONTRAST-HELLIGKEIT-FARBE

einzustellen.

Mittels den Ikonen Bright, Soft, Normal lässt sich auch der Licht-Effekt auf dem Bildschirm einstellen.



## AUDIO

<> Son droite/gauche.

^ Son antérieur ou postérieur .

-/+ Régler les graves.

-/+ Régler les sons aigus.

■ Activer/désactiver SUBWOOFER e LOUDNESS.

<> EQ Sélectionner 8 différents modalités d'égalisation préétabli.

## AUDIO

<> Ton rechts/links.

^ Ton Front/Heck.

-/+ Tieftöne.

-/+ Treble.

■ Aktivierung/Deaktivierung von SUBWOOFER und LOUDNESS.

<> EQ - 8 vorgegebene Equalizer-Modalitäten wählen.



## DATE EE HORAIRE



A travers l'icône entrer dans l'écran du réglage.

- Time Display **ON/OFF** pour visualiser l'horaire.
- Time Mode **12/24** pour sélectionner la modalité de visualisation.
- Option **Time/Date** pour se positionner sur la voix à modifier (horaire ou date). Effectuer les modifications à travers les icônes ^ v

## DATUM / UHRZEIT



Durch die Ikone , die Einstellungs-Tafel betreten.

- Time Display ON/OFF, um die Uhrzeit auszuweisen.
- Time Mode 12/24, um den Display-Modus zu wählen.
- Option Time/Date, auf die gewünschte Funktion gehen (Uhrzeit/Datum), dann, mittels Ikone ^ v Änderung vornehmen.



## SYSTEME

✂ A travers l'icône entrer dans l'écran du réglage.

- Beep **ON/OFF** active/désactive son touche.
- GPS Remix **ON/OFF** active/désactive la voix du navigateur.
- Radio Region à travers les icônes < > sélectionnées la région dans laquelle on y trouve.
- Dual color pour changer la rétro illumination des touches (Rouge-Bleu).

## SYSTEM

✂ Durch die Ikone , die Einstellungs-Tafel betreten.

- Beep **ON/OFF**, um den Tasten-Ton zu aktivieren/deaktivieren.
- GPS Remix **ON/OFF**, um die Navigations-Stimme zu aktivieren/deaktivieren
- Radio Region: durch die Ikonen < > , die Region, in der man sich befindet, einstellen.
- Dual Color, um die Tasten-Beleuchtung (Rot/Blau) zu wählen.



## TOUCHSCREEN

A travers l'icône @ entrer dans l'écran du réglage. Si les images sur l'écran et le touch ne coïncident pas, il est nécessaire effectuer la calibration. Appuyer le symbole X présent sur l'écran pour plus de 2 seconds jusqu'à visualiser l'inscription "calibration effectuée".

## TOUCHSCREEN

Durch die Ikone @ , die Einstellungs-Tafel betreten. Falls die auf dem Bildschirm erscheinenden Bilder nicht mit dem Touchscreen übereinstimmen, muss eine Kalibrierung durchgeführt werden. Das Symbol X auf dem Bildschirm, mindestens 2 Sekunden drücken, bis der Hinweis „Kalibrierung durchgeführt“ erscheint.



## HINTERGRUND-PERSONALISIERUNG

Im Hauptmenü, kann man, durch die Ikone (WALLPAPER), eine Reihe von Hintergrund-Bildern besichtigen und auf dem Bildschirm übernehmen.

## PERSONALISATION FOND

Dans le menu principal, à travers l'icône (WALLPAPER) on peut sélectionner une série de fonds à appliquer à l'écran.



**RADIO**

A travers l'icône  on entre dans la fonction RADIO.

**RADIO**

Durch die Ikone  betritt man die RADIO-Funktion.



**RECHERCHE STATIONS**

**Automatique.** Pour se syntoniser en automatique sur une station toucher les icônes <> sur le touchscreen.

**Manuel.** Pour se syntoniser en manuel sur une station tenir appuyer les icônes <> sur le touchscreen. On peut être sauver jusqu'à 30 stations (18 FM et 12 MW).

**SENDER-SUCHE**

Automatisch. Um automatisch einen Sender einzustellen, die Ikonen <> auf dem Touchscreen antasten.

Manuell. Um von Hand einen Sender einzustellen, die Ikonen <> auf dem Touchscreen gedrückt halten. Es lassen sich insgesamt 30 Sender einspeichern (18 FM und 12 MW).



**SAUVETAGE STATIONS**

**Automatique.** Il est possible sauver jusqu'à 6 stations pour chaque bande. Sélectionner la bande désirée et tenir appuyer le touche AMS, en automatique les stations avec une bonne réception seront sauvées.

**Manuel.** Pour sauver une spécifique station radio, se syntoniser et tenir appuyer un des touche (1-6). Chaque station précédemment sauvée sur le même numéro sera effacée.

**SENDER-EINSPEICHERUNG**

**Automatisch.** Auf jedem Frequenz-Band, lassen sich bis zu 6 Sender einspeichern. Das gewünschte Frequenz-Band wählen und die AMS-Taste gedrückt halten. Demzufolge werden automatisch die gut empfangenen Sender eingespeichert.

**Manuell.** Um einen bestimmten Radio-Sender einzuspeichern, sich auf den Sender stationieren und eine der Tasten (1-6) gedrückt halten. Die vorher, auf dieser Taste eingespeicherten Sender werden dadurch automatisch gelöscht und ersetzt.





## FUNZIONI RADIO

- **BAND** Sélectionne Bande Radio 3 FM - 2 AM.
- **AMS** Balayage des fréquences radio automatiquement et mémorisation des premiers 6 plus forts.
- **INTRO** pour écouter les premiers seconds de chaque station radio mémorisée.

## RADIO FUNCTION

- **BAND**, für die Wahl der Radio-Frequenzbänder 3 FM – 2 AM.
- **AMS**, automatisches Scrolling aller Radio-Frequenzen, mit Einspeicherung der 6 stärksten.
- **INTRO**, die eingespeicherten Sender werden jeweils kurz angespielt.



## FONCTIONS RADIO

- **RDS** informations trafic
  - PI Programme d'identification
  - PS Programme prénom
  - AF Liste fréquence alternatives
  - TP Programme trafic
  - TA Information sur le trafic
  - PTY Sélectionne type programme musicale.
- ⚙️ Pour entrer dans le menu de réglage.

## RADIO-FUNKTIONEN

- **RDS**, Senderinfos.
  - PI, Identifizierungs-Programm.
  - PS, Programm-Name
  - AF, Alternativ-Frequenzen
  - TP, Verkehrs-Programm
  - TA, Verkehrs-Infos
  - PTY, Wahl der Musik-Art
- ⚙️ Um in das Einstellungs-Menü zu gelangen.



## REGLAGES RADIO

- ⚙️ Pour entrer dans le menu de réglage.
- ON/OFF** active ou désactive service.
- LOC • ST • EON • PTY • TA • AF • REG

## RADIO-EINSTELLUNGEN

- Um das Einstellungs-Menü zu betreten.
- ON/OFF**, Funktion aktivieren/deaktivieren.
- LOC • ST • EON • PTY • TA • AF • REG



### FONCTION USB/SD

A l'insertion de USB/SD le contenu sera visualisé automatiquement. Sélectionner le type de fiche à travers l'icône relative.

MUSIQUE - VIDEO - IMAGES.

PLAYING pour engager la reproduction.

### USB-SD-FUNKTIONEN

Beim Eingeben von USB/SD, werden die eingespeicherten Dateien automatisch ausgewiesen. Die gewünschte Datei anhand der jeweiligen Ikone anwählen.

MUSIK -VIDEOS - BILDER.

PLAYING, um die Wiedergabe zu starten.



### REPRODUCTION MUSIQUE

Sélectionner la trace désirée pour engager la reproduction.

- ▶|| Pour engager ou interrompre la reproduction.
- Stop à la reproduction.
- ◀◀▶▶ Pour changer la trace.
- ↺ Répétition trace /dossier/disque.
- ☰ Pour sélectionner une trace spécifique en utilisant les numéros de 0-9.

### MUSIK-WIEDERGABE

Um die Wiedergabe zu starten, einfach das gewünschte Musik-Stück wählen.

- ▶|| Wiedergabe starten / unterbrechen.
- Wiedergabe stoppen.
- ◀◀▶▶ Anderes Musik-Stück spielen.
- ↺ Wiederhole Stück/Ordner/CD.
- ☰ Ein ganz bestimmtes Musik-Stück wählen, durch die Tasten 0-9.

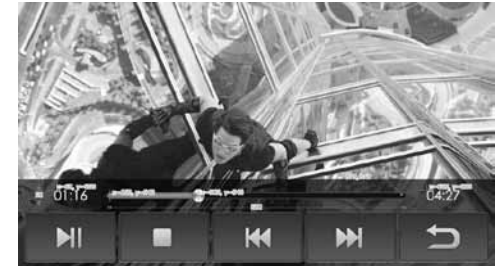

### REPRODUCTION VIDÉO

- ▶|| Pour engager ou interrompre la reproduction.
  - Stop à la reproduction.
  - ◀◀▶▶ Pour avant/arrière rapide et chapitres.
  - ↺ Pour retourner au menu.
- Toucher l'écran pour faire apparaître le menu quand le vidéo est en reproduction.

### VIDEO-WIEDERGABE

- ▶|| Wiedergabe starten / unterbrechen.
  - Wiedergabe stoppen.
  - ◀◀▶▶ Schnell vorwärts / rückwärts und Kapitel.
  - ↺ Zurück zum Menü.
- Touch-screen antasten, um, während der Film-Wiedergabe, das Menü auszuweisen.

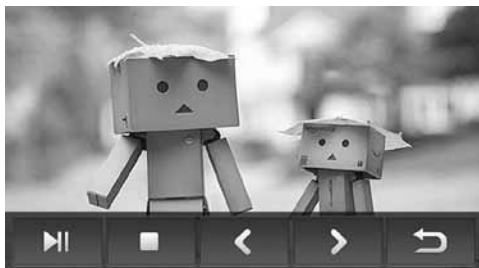

### REPRODUCTION PHOTO

- ▶❏ Pour engager ou interrompre la reproduction.
- Stop à la reproduction.
- <> Pour avant/arrière rapide et chapitres.
- ↻ Pour retourner au menu.

Toucher l'écran pour faire apparaître le menu quand les images sont en reproduction.

### FOTO-WIEDERGABE

- ▶❏ Wiedergabe starten / unterbrechen.
- Wiedergabe stoppen.
- <> Schnell vorwärts / rückwärts und Kapitel.
- ↻ Zurück zum Menü.

Touch-screen antasten, um, während der Foto-Wiedergabe, das Menü auszuweisen.



## ACCOUPEMENT MOBILE

Sélectionner modalité BT sur le menu principal.

- Activer la fonction bluetooth sur le mobile et rechercher nouveaux dispositifs.
- Sélectionner VM067 dans la liste dispositifs, insérer le mot de passe 1234 quand demandé.

A accouplement terminé on visualisera le prénom du mobile.

## MOBIL-TELEFON KOPPELN

Aus dem Haupt-Menü, BT-Funktion wählen.

- Auf dem Mobil-Telefon, Bluetooth-Funktion aktivieren und weitere Geräte ausfindig machen.
- Aus der Geräte-Liste, VM067 wählen.

Auf Anfrage, das Passwort 1234 eingeben.

Sobald die Koppelung abgeschlossen ist, erscheint der Name des Mobil-Telefons.



## SINCRONISATION CARNET D'ADRESSE

 Appuyer pour entrer dans le Carnet d'adresse et Registre appels.



Appuyer et le carnet d'adresse du mobile sera téléchargé dans la mémoire de l'autoradio. Le temps pour l'opération change selon le numéro des contacts.

## SYNCHRONISIERUNG DES TELEFON-REGISTERS

 Drücken, um Telefon- und Gespräche-Register zu betreten.



Drücken, um Telefon-Register in den Radio-Speicher zu laden. Das Herunterladen dauert verschieden lang, je nach Anzahl der Telefon-Nummern.

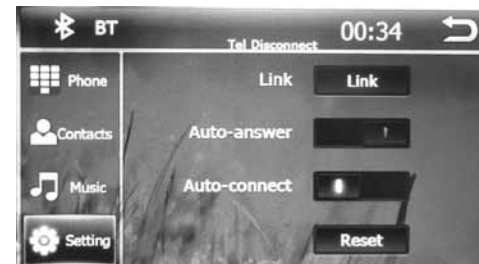

## OPTIONS BLUETOOTH

PAIR appuyer sur ce touche pour accoupler unité et mobile manuellement.

AUTO-ANSWER établit la réponse automatique.

CONNECT établit la reconnexion automatique.

RESET Pour effacer les réglages Bluetooth.

## BLUETOOTH-OPTIONEN

PAIR drücken, um das Gerät manuell mit dem Mobiltelefon zu koppeln.







AUTO-ANSWER, Anruf wird automatisch in Empfang genommen.

CONNECT, Verbindung wird automatisch wiederholt.

REST, um die Bluetooth-Einstellungen zu löschen.









## APPELER DE L'ECRAN

-  Appel des touches numériques.
-  Appel du carnet d'adresse téléphonique.
-  Entrer dans la fonction audio streaming.
-  Options Bluetooth
-  Envoie une appel.
-  Termine la conversation ou refuse l'appel qui arrive.

Note: L'appel qui arrive interrompra les autres fonctions qui seront restaurées une fois terminé.

## ANRUF VOM BILDSCHIRM STARTEN



-  Anruf mittels Nummern-Tastatur.
-  Anruf ab Telefon-Register.
-  Audio-Streaming-Funktion betreten.
-  Bluetooth-Optionen.
-  Anruf starten.
-  Gespräch beenden oder ankommenden Anruf zurückweisen.

Hinweis: ankommende Anrufe sorgen für die vorübergehende Unterbrechung aller übrigen Funktionen. Nach dem Gespräch kommen diese Funktionen wieder zur Wirkung.





## RECEVOIR UNE APPEL

Quand une appel est en arrive, sur la moitié de l'écran sera visualisé le numéro appels.

-  Répond à une appel.
-  Termine la conversation ou refuse l'appel qui arrive.

## ANRUF IN EMPFANG NEHMEN

Bei Ankunft eines Telefonats, wird die Telefonnummer im mittleren Bereich des Display angezeigt.



-  Anruf in Empfang nehmen.
-  Gespräch beenden oder ankommenden Anruf zurückweisen.



## REPRODUCTION MUSIQUE BLUETOOTH

Si le mobile connecté supporte le profil A2DP il est possible écouter les morceaux musicaux.



Si le dispositif supporte AVRCP il sera possible contrôler les morceaux musicaux directement du touch screen.

-  pour engager ou interrompre la reproduction.
-  stop à la reproduction.
-  morceau précédent/successif.

## MUSIK-WIEDERGABE DURCH BLUETOOTH

Soweit das Mobil-Telefon über das A2DP-Profil operiert, kann man auch Musik hören.

Soweit das Mobil-Telefon AVRCP-kompatibel ist, lassen sich die Musikstücke direkt auf dem Touchscreen kontrollieren.





-  Wiedergabe starten / unterbrechen.
-  Wiedergabe stoppen.
-  Stück davor / danach



## RÉGLAGES COMMANDES AU VOLANT

 Appuyer l'icône pour entrer dans la programmation des commandes au volant.

Suivre la procédure suivant:





- 1 Appuyer un des compartiment sur la gauche de l'écran (ex. cadre 1).
- 2 Appuyer sur le volant de la voiture le commande à assigner (ex. ).
- 3 Traîner l'icône de la fonction désirée (ex. ) dans le compartiment sélectionné.
- 4 Répéter la séquence de 1 à 3 pour tous les commandes présents sur le volant.
- 5 Une fois terminé l'assignation, appuyer  et sortir de la programmation en appuyant .

Pour effacer un commande assigné, le traîner du compartiment à gauche au compartiment des fonctions à droite.

## EINSTELLUNG DER LENKRAD-STEUERUNGEN



Ikone drücken, um die Einstellungen der Lenkrad-Steuerungen, nach folgender Prozedur, durchzuführen:

- 1 Links auf dem Bildschirm, eine der gegebenen Optionen wählen (z.B. Option 1).
- 2 Auf dem Lenkrad, die festzulegende Steuerung drücken (z.B. ).
- 3 Ikone der gewünschten Steuerung (z.B. ) in die gewählte Options-Zelle setzen.
- 4 Zu jeder einzelnen Lenkrad-Steuerung, die drei Vorgänge 1 bis 3 wiederholen.
- 5 Nachdem alle Steuerungen zugewiesen sind, Taste  drücken und die Programmierung verlassen, durch Drücken und Taste .

Um eine bereits zugewiesene Steuerung zu löschen, die betreffende Steuerung von der Options-Zelle links, auf die Options-Zelle rechts auf dem Bildschirm, versetzen.



## NAVIGATION

Quand on active pour la première fois la carte iGo (optionnel), il faut sélectionner le fichier exécutif mobilenavigator.exe dans les réglages.

- Accéder au menu paramètre du software.



## NAVIGATION

Bei der Erst-Aktivierung der iGO-Mappen (Optional), die Betriebs-Datei mobilenavigator.exe wählen und Einstellungen vornehmen.

- Das Software-Einstellungs-Menü betreten.



## PARAMÈTRE MODULE GPS



- Passer au second écran.

## EINSTELLUNG DES GPS-MODULS



- Auf die zweite Seite gehen.



- Appuyer GPS.



- GPS drücken



- Appuyer sur le trait de GPS ACTIF, Et après sur le RELÈVEMENT AUTOMATIQUE.

- GPS-AKTIV drücken bzw. abhaken. Dann auf AUTOMATISCHE ERKENNUNG drücken.



- Attendre l'acquisition des données et appuyer ok.
- Faire référence au manuel iGo pour les instructions sur le software de navigation.

- Die Ermittlung der Daten abwarten und OK drücken.
- Die Anweisungen zur Navigations-Software sind dem iGO-Handbuch zu entnehmen.

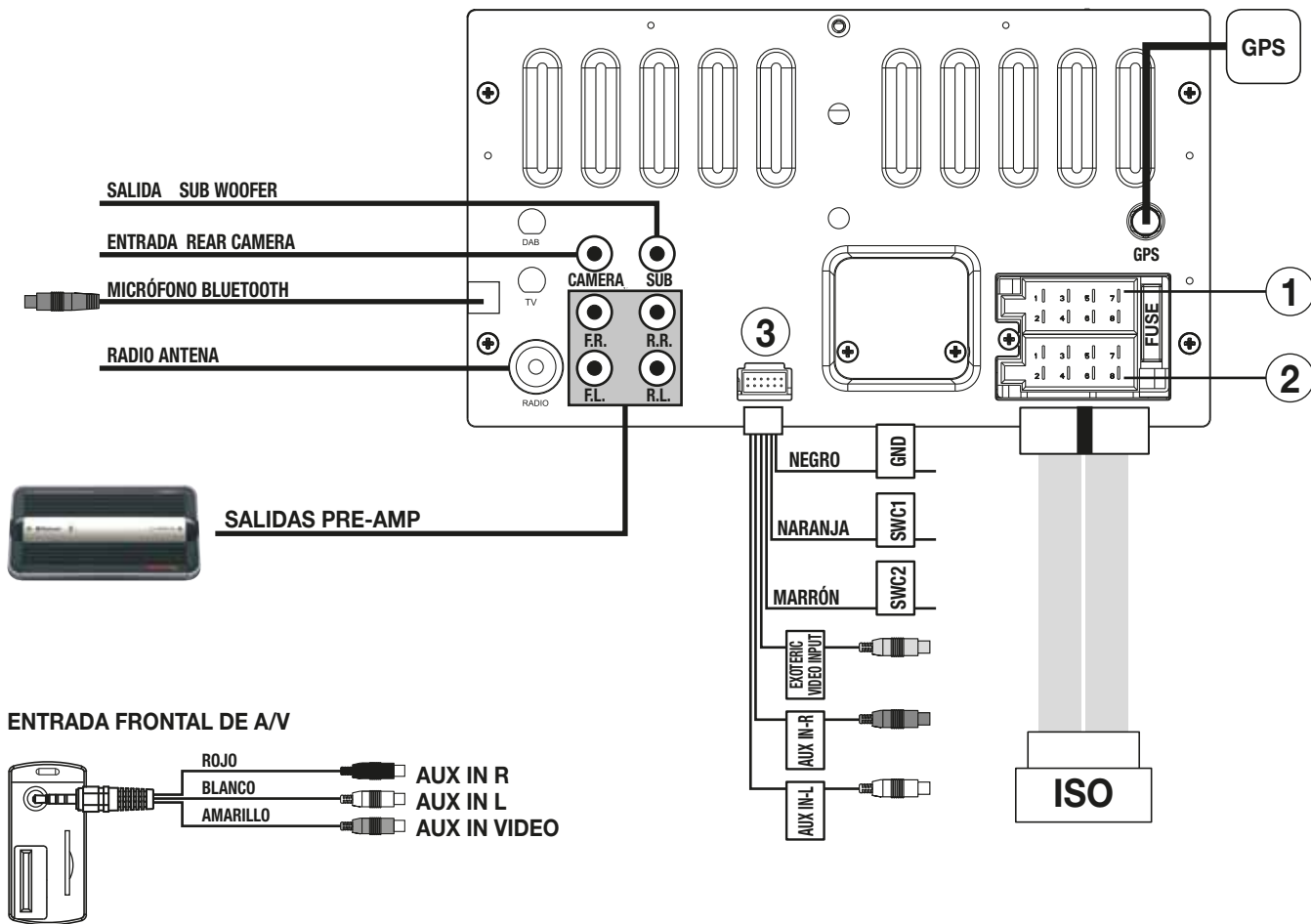



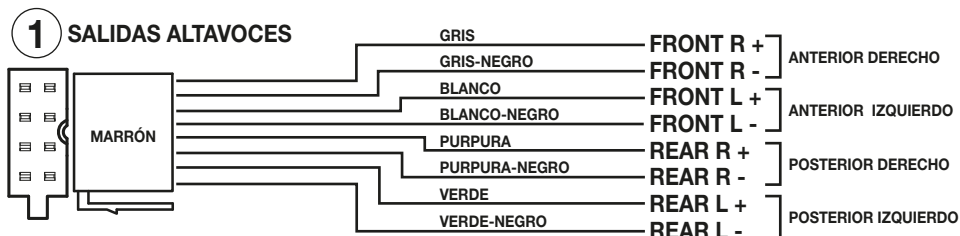

En algunos coches durante el arranque del motor el VM067 podría apagarse y después encenderse. Para evitar esta molestias conectar el temporizador de encendido art. **5/146** (opcional) al conector de alimentación.

## MANDOS DE VOLANTE-ENTRADA A/V

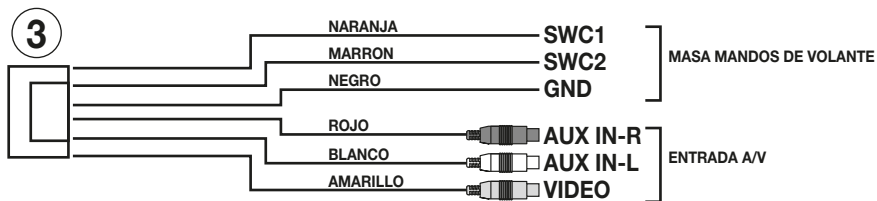

## MANDOS DE VOLANTE CON PROTOCOLO RESISTIVO

Para la conexión al conector original del coche utilizar los esquemas presentes en el manual de instrucción del interfaz 4/083 o 4/085

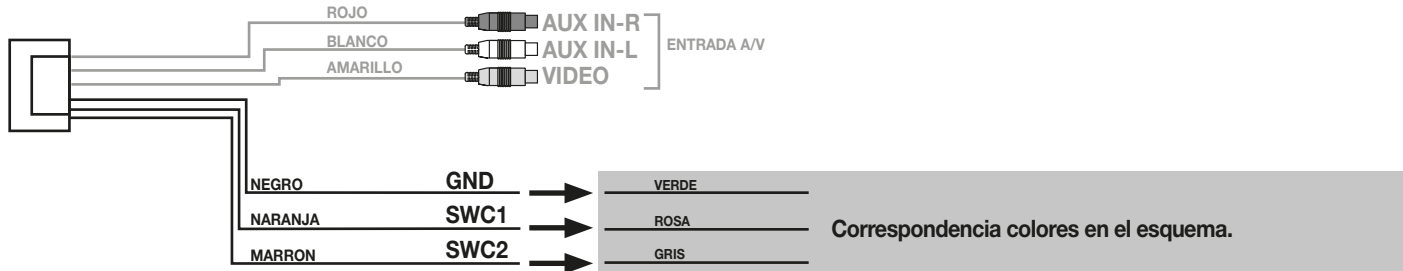

## MANDOS DE VOLANTE CAN-BUS

Utilizar el interfaz CAN BUS 4/070 o 4/073 memorizando el perfil autoradio sobre el VM041. Asignar los mandos de volante como las instrucciones que se detallan en la página 15.

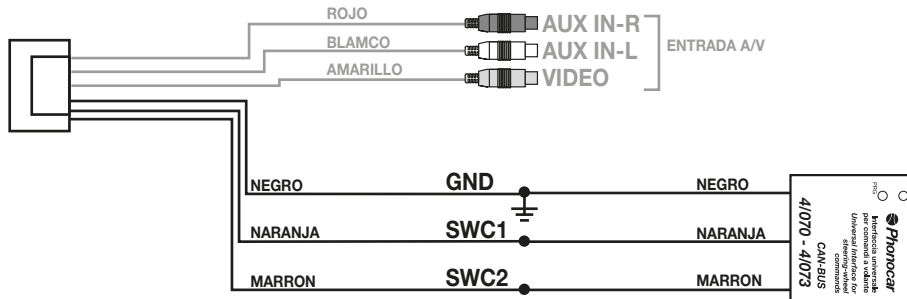

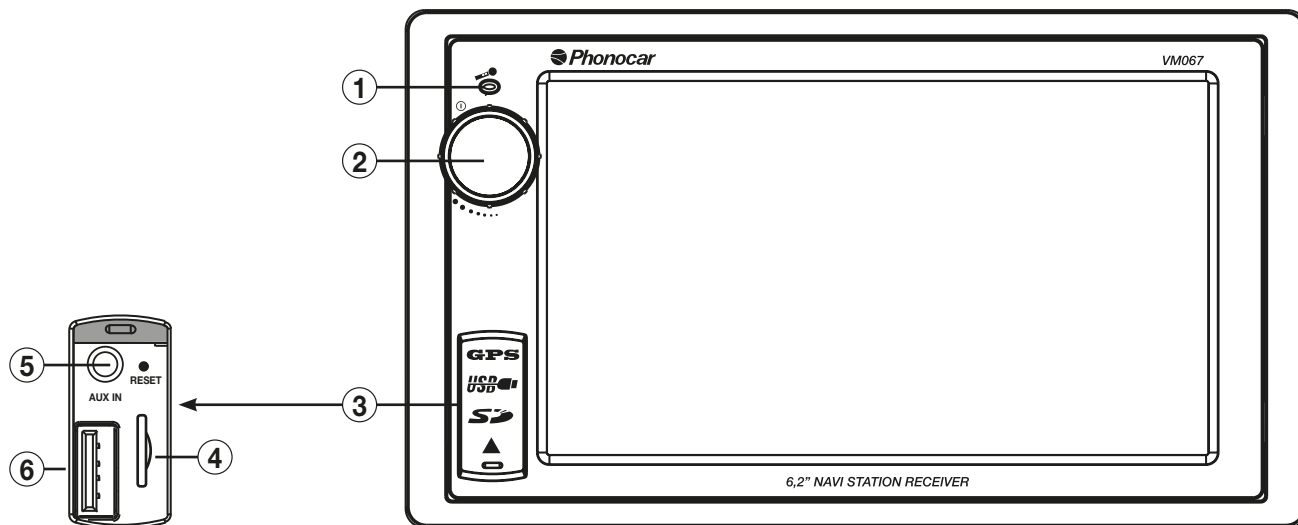

1. Microfono.
2. Encendido-Apagado / Volumen / Función GPS
3. Protección para entrada AUX IN - SD CARD - USB
4. Ranura para SD CARD GPS
5. AUX IN
6. Puerto USB

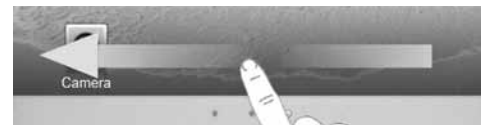
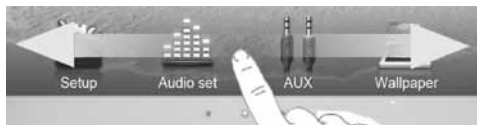

Presionar la tecla Encendido/Apagado en el panel frontal del autoradio, aparecerá la función RADIO , con el icono ↻ se pasa al menú principal. El menú está formado por tres diferentes ventanas que se visualizarán deslizando el dedo en la pantalla. Tocando los iconos se selecciona la fuente o la función deseada.



Presionar el icono Setup en el panel del menú principal para modificar las siguientes funciones: video, audio, hora, sistema, táctil.



## Para configurar CONTRASTE-BRILLO-COLOR

Con los iconos **Bright**, **Soft** y **Normal** se puede ajustar también el efecto luz en la pantalla.

## AUDIO

- <> Sonido derecha/izquierda.
- ^ Sonido anterior o posterior.
- ∓ Ajusta los graves.
- ∓ Ajusta los agudos.
- Activar/desactivar SUBWOOFER y LOUDNESS
- <> EQ Mediante los iconos seleccionar 8 diferentes modos de equalización pre-configurados.

## FECHA Y HORA

- 🕒 Entra en la ventana de ajuste
- ON/OFF Para visualizar el horario.
- 12/24 Para seleccionar el modo de visualización.
- Time/Date Para posicionarse en la función que se desea modificar (horario o fecha). Efectuar las modificaciones mediante los iconos ⬆️⬆️



## SISTEMA

Mediante el icono  entrar en la ventana de ajuste.

- Beep **ON/OFF** activa/desactiva el sonido de las teclas.
- GPS Remix **ON/OFF** activa/desactiva la voz del navegador
- Radio Región mediante los iconos seleccionar la región de residencia
- Dual color para cambiar la retro iluminación de las teclas (Rojo-Azul).



## PANTALLA TACTIL

Mediante el icono  entrar en la ventana de ajuste. En el caso de que las imágenes y el táctil en la pantalla no coincidan, es necesario efectuar la calibración. Presionar el símbolo **X** presente en la pantalla durante más de 2 segundos hasta que no aparezca el escrito "calibración efectuada".



## PERSONALIZACION DEL FONDO DE PANTALLA

En el menú principal, mediante el icono  (WALLPAPER) se puede seleccionar una serie de fondos que se pueden utilizar en la pantalla



## RADIO

Mediante el icono  se entra en la función RADIO.



## BUSQUEDA EMISORAS

**Automatica.** Para sintonizarse en automático en una emisora, tocar los iconos <> en la pantalla táctil.

**Manual.** Para sintonizarse de forma manual en una emisora, tener presionado los iconos <> en la pantalla táctil. Pueden ser memorizadas hasta 30 emisoras (18 FM y 12 MW).



## MEMORIZAR EMISORAS

**Automatico.** Es posible memorizar hasta 6 emisoras por cada banda. Seleccionar la banda deseada y tener presionada la tecla AMS, en automático serán memorizadas las emisoras con buena recepción.

**Manual.** Para memorizar una emisora de radio específica, sintonizarse y tener presionada una de las teclas (1-6). Cada emisora precedentemente memorizada en la misma tecla será cancelada.



## FUNCIONES RADIO

- **BAND** Selecciona Bandas Radio 3 FM - 2 AM.
- **AMS** Escansión de las frecuencias radio en automático y memoriza las 6 primeras más fuertes.
- **INTRO** para escuchar los primeros segundos de cada emisora memorizada.



## FUNCIONES RADIO

- **RDS** visualiza informaciones de la emisora
  - PI Programa de identificación
  - PS Nombre Programa
  - AF Lista frecuencias alternativas
  - TP Programa trafico
  - TA Información sobre el tráfico
  - PTY Selecciona tipo de programa musical.
- ⚙️ Para entrar en el menú de configuración.



## CONFIGURACION RADIO

- ⚙️ Para entrar en el menú de configuración.
- ON/OFF** activa o desactiva servicio.
- LOC • ST • EON • PTY • TA • AF • REG





## FUNCIONES USB/SD

En el momento que se introduce una USB/SD el contenido será visualizado automáticamente.

Seleccionar el tipo de archivo mediante el relativo icono.

MUSICA - VIDEO – IMAGENES.

PLAYING para iniciar la reproducción.



## REPRODUCCION MUSICA

Seleccionar la canción deseada para iniciar la reproducción.

- ▶| Para iniciar o interrumpir la reproducción.
- Stop a la reproducción.
- ◀▶▶▶ Para cambiar de canción.
- ↻ Repetición canción/carpeta/disco.
- ⋮ Para seleccionar una canción especifica usando los números de 0-9.

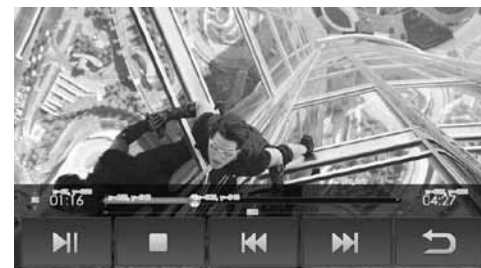

## REPRODUCCION VIDEO

- ▶| Para iniciar o interrumpir la reproducción.
- Stop a la reproducción.
- ◀▶▶▶ Para adelante/atrás rápido y capítulos.
- ↻ Para volver al menú.

Tocar la pantalla para que aparezca el menú cuando el filmado se está reproduciendo.

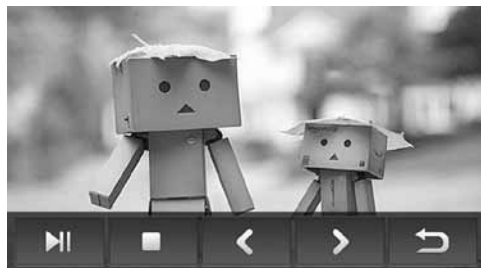

## REPRODUCCION FOTO

- ▶❏ Para iniciar o interrumpir la reproducción.
- Stop a la reproducción.
- <> Para adelante/atrás rápido y capítulos.
- ↺ Para volver al menú.

Tocar la pantalla para que aparezca el menú cuando el filmado se está reproduciendo.



## EMPAREJAR TELEFONO



Seleccionar modo BT en el menú principal.

- Activar la función bluetooth en el teléfono y buscar nuevos dispositivos.
- Seleccionar VM067 en la lista dispositivos,

Introducir la password 1234 cuando sea requerida. Una vez acoplado aparecerá el nombre del teléfono.



## SINCRONIZACION CONTACTOS

- 
**Contacts** Presionar para entrar en Contactos y en el Registro de las llamadas.
- 
 Presionar y los contactos presentes en el teléfono se descargarán en la memoria del autoradio. El tiempo necesario para esta operación varía en base a la cantidad de contactos que hay que descargar.

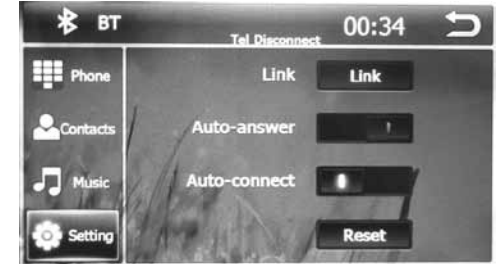







## OPCIONES BLUETOOTH

- **LINK** Presionar esta tecla para acoplar de forma manual la unidad y el móvil.
- **AUTO-ANSWER** configura la contestación automática.
- **CONNECT** Configura la re-conexión automática.
- **RESET** Para cancelar las configuraciones Bluetooth.



## LLAMAR DESDE LA PANTALLA



-  Llamada desde el teclado numérico.
-  Llamada desde la lista de contacto.
-  Entra en la función audio streaming.
-  Opciones Bluetooth
-  Realizar llamada.
-  Termina la conversación o rechaza la llamada entrante.

Nota: La llamada entrante interrumpe las demás funciones, al finalizar la llamada vuelve a la función inicial.



## RECIBIR UNA LLAMADA

Cuando hay una llamada entrante, en una mitad del display aparecerá el número de teléfono de quien está llamando.



-  Contesta a una llamada.
-  Termina la conversación o rechaza la llamada entrante.



## REPRODUCCION MUSICA BLUETOOTH

En el caso de que el teléfono emparejado soporta el perfil A2DP es posible escuchar las canciones presentes en el teléfono.

Además si el dispositivo soporta AVRCP será posible controlar las canciones directamente desde la pantalla táctil.

-  Para iniciar o interrumpir la reproducción.
-  Stop a la reproducción.
-  Canción precedente/siguiente.







## CONFIGURACION MANDOS DE VOLANTE



Presionar el icono para entrar en la programación de los mandos de volante.

Seguir el siguiente procedimiento:

- 1 Presionar uno de los recuadros a la izquierda de la pantalla (ej. casilla 1).
- 2 Presionar en el volante el mando que se desea asignar (es. )
- 3 Deslizar el icono de la función deseada (es. ) en el recuadro seleccionado.
- 4 Repetir la secuencia de 1 a 3 para todos los mandos presentes en el volante.
- 5 Terminada la asignación presionar  y salir de la programación presionando .

Para cancelar un mando asignado deslizarlo desde el recuadro de la izquierda al recuadro de las funciones de la derecha.



## NAVEGACION

En la primera activación de la cartografía iGO (opcional) seleccionar el archivo ejecutable mobilenavigator.exe en los ajustes.

- Acceder al menú ajustes del software.



## CONFIGURACION MODULO GPS



- Pasa a la segunda ventana

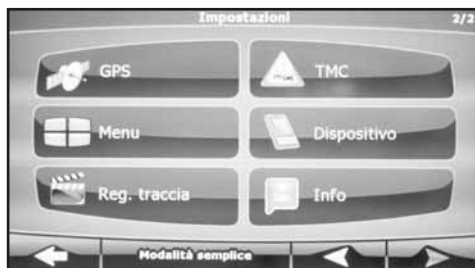

- Presionar GPS



- Presionar en la casilla de GPS ACTIVADO A continuación en DETECCIÓN AUTOMATICA



- Esperar la adquisición de los datos y presionar ok.
- Tomar como punto de referencia el manual iGO para las instrucciones sobre el software de navegación.

# CARATTERISTICHE TECNICHE • TECHNICAL FEATURES • CARACTERISTIQUES TECHNIQUES TECHNISCHE DATEN • CARACTERISTICAS TECNICAS

Reference Supply Voltage ..... 12V(DC)  
Operating Voltage Range ..... 10.5 - 15.8V(DC)  
Max Operating Current ..... 15A

## FM

Signal Noise Ratio .....  $\geq 60$ dB  
Residual Noise Sensitivity(S/N=30dB ..... 18dB $\mu$ V  
Frequency Response( $\pm 3$ dB ..... 40Hz~12.5KHz  
Station Seeking Level ..... 20~28dB $\mu$ V  
Distortion .....  $\leq 1.5\%$   
Stereo Separation(1KHz .....  $\geq 25$ dB  
Antenna Impedance ..... 75 $\Omega$

## AM

Residual Noise Sensitivity (S/N=20dB ..... 30dB $\mu$ V  
Selectivity ( $\pm 9$ KHz .....  $\geq 50$ dB

## LCD

Screen size ..... 6.2inches(16:9)  
Display resolution ..... 800X480dots  
Contrast ratio ..... 500  
Brightness ..... 300cd/m<sup>2</sup>

## AUX IN

Distortion .....  $\leq 0.5\%$   
Frequency Response( $\pm 3$ dB ..... 20Hz~20KHz  
Audio Input Level ..... 1Vrms

## Audio

Audio Output Impedance ..... 100 $\Omega$   
Audio Output Level ..... 4Vrms(Max)

## Video

Normal Video Input Level(CVBS ..... 1.0 $\pm 0.2$ V  
Video Input Impedance ..... 75 $\Omega$   
Video Output Impedance ..... 75 $\Omega$   
Video Output Level ..... 1.0 $\pm 0.2$ V

## FORMATI SUPPORTATI

Formattazione USB/SD-CARD: FAT16 – FAT32 • Bit rate MP3 : 32-320 Kbps • WMA: V9 o successive  
Numero di livelli massimo nella directory: 8 • Max album per cartella: 99 • Max tracce per cartella: 999  
ID3TAG: V2 o successive • Nomi dei file in Unicode UTF8 (lunghezza massima 128 caratteri)

## FORMATI NON SUPPORTATI

Un album o una cartella senza alcun file MP3/WMA non verrà visualizzato sul display.  
I file non compatibili o non supportati saranno saltati, ignorati e non riprodotti **(AAC, WMV, PCM / WMA con protezione DRM e in formato LOSSLESS)**.

## SUPPORTED FORMATS

Formating USB/SD-CARD: FAT16 – FAT32 • Bit rate MP3 : 32-320 Kbps • WMA: V9 or successive  
Maximum levels of Directory: 8 • Max albums per Folder: 99 • Max Tracks per Folder: 999  
ID3TAG: V2 or successive • File-Names in Unicode UTF8 (max. length 128 digits)

## NON-SUPPORTED FORMATS

An Album or a Folder lacking MP3/WMA-files at all, will NOT be visualized on the display.  
The files which are not compatible or not supported, will be left behind, in other words ignored and not reproduced **(AAC, WMV, PCM / WMA with DRM-protection and in LOSSLESS-format)**.

## FORMATS SUPPORTÉS

Formatage USB / CARTE SD: FAT 32. BIT rate MP: 32 -320 Kbps. WMA V9 ou successive  
Nombre des niveaux maximum dans la directory: 8. Max album par dossier: 99. Max trace par dossier: 999  
ID3TAG: V2 ou successive. Noms des fichiers en Unicode UTF8 (Longueur maximale 128 caractères)

## FORMATS PAS SUPPORTÉS

Un album ou un dossier sans aucun fichier MP3 / WMA ne sera pas visualisé sur l'afficheur  
Les fichiers pas compatibles ou pas supportés seront sautés, ignorés et pas reproduits **(AAC, WMA, PCM / WMA avec protection DRM et en format LOSSLESS)**.

## FORMAT-KOMPATIBILITÄT

Formatierung USB/SD-CARD: FAT16 – FAT32 • Bit rate MP3 : 32-320 Kbps • WMA: V9 oder höher • Maximale Register-Stufen: 8 • Max Album-Anzahl pro Ordner: 99 • Max Stücke pro Datei: 999 • ID3TAG: V2 oder höher  
Datei-Namen in Unicode UTF8 (max. Länge 128 Buchstaben)

## NICHT-KOMPATIBLE FORMATE

Ein Album oder ein Ordner, die ganz ohne MP3/WMA-Dateien sind, lassen sich nicht auf dem Display ausweisen.  
Alle nicht-kompatiblen oder nicht lesbaren Dateien werden ganz einfach übersprungen bzw. ignoriert, d.h. nicht abgespielt **(AAC, WMV, PCM / WMA mit DRM-Schutz und in LOSSLESS-Format)**.

## FORMATOS SOPORTADOS

Formateado USB/SD-CARD: FAT16 – FAT32. • Bit rate MP3 : 32-320 Kbps. • WMA: V9 o siguientes.  
• Numero de nivel máximo en la directory: 8. • Max álbum por carpeta: 99. • Max pistas por carpeta: 999.  
• ID3TAG: V2 o siguientes. • Nombres de los archivos en Unicode UTF8 (largo máximo 128 caracteres).

## FORMATOS NO SOPORTADOS

Un álbum o una carpeta sin algún archivo MP3/WMA no será visualizado en la pantalla. Los archivos no compatibles o no soportados no serán tenidos en consideración, y no se reproducirán. **(AAC, WMV, PCM / WMA con protección DRM y en formato LOSSLESS)**.



DICHIARAZIONE DI CONFORMITÀ alle direttive 1999/5/EC R&TTE  
DECLARATION OF CONFORMITY to the directives 1999/5/EC R&TTE

**IT** Phonocar dichiara che il VM067 è conforme ai requisiti essenziali e a tutte le altre disposizioni pertinenti stabilite dalla direttiva 1999/5/CE.

**GB** Phonocar declares that this unit VM067 is in compliance with the essential requirements and other relevant provisions of Directive 1999/5/EC.

**FR** Phonocar déclare que l'appareil VM067 est conforme aux exigences essentielles et aux autres dispositions pertinentes de la directive 1999/5/EC.

**D** Phonocar erklärt, dass dieser VM067 in Übereinstimmung ist mit den grundlegenden Anforderungen und den anderen relevanten Vorschriften der Richtlinie 1999/5/EC.

**E** Phonocar declara que el VM067 cumple con los requisitos esenciales y cualesquiera otras disposiciones aplicables o exigibles de la Directiva 1999/5/EC.

EN 55013: 2001+A1: 2003+A2: 2006 • EN 55020: 2007+A11: 2011 • EN 60065: 2002+A1: 2006+A11: 2008+A2: 2010+A12: 2011



10R - 03 2505



Il prodotto non deve essere smaltito con i rifiuti domestici. Per ulteriori informazioni consultare il sito [www.phonocar.it](http://www.phonocar.it)

*This Product must NOT be treated as a domestic waste. For further information, please read homepage [www.phonocar.it](http://www.phonocar.it)*